

Ditec EL31R

IP1851EN

Installation Manual for control panel for 24V₌ automations with built-in radio.

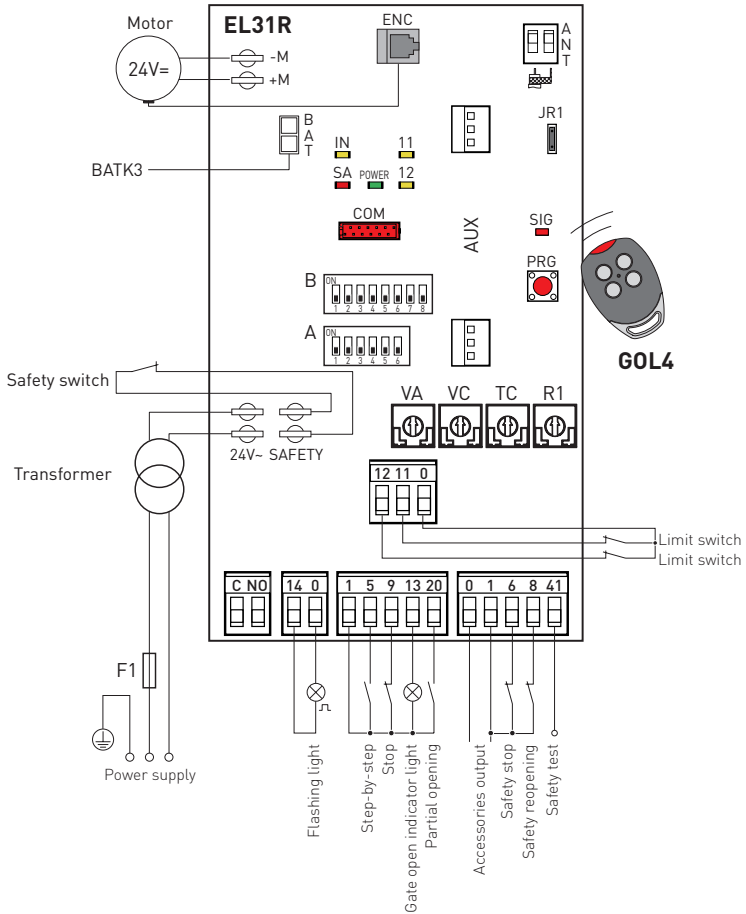

Index

Subject		Page
1.	General safety precautions	30
2.	EC declaration of conformity	31
3.	Technical specifications	31
3.1	Applications	31
4.	Commands	32
4.1	Self-controlled safety edge	33
5.	Sliding gates outputs and accessories	34
6.	Barriers outputs and accessories	35
7.	Settings	36
7.1	Trimmers	36
7.2	Sliding gates dip-switches	37
7.3	Barriers dip-switches	38
7.4	Jumper	39
7.5	Signals	39
8.	Radio	40
9.	Working modes for sliding gates	41
10.	Start-up	42
10.1	Sliding gates start-up	42
10.2	Barriers start-up	43
11.	Troubleshooting	44
12.	Application example for sliding gates	46
13.	Application example for barriers	47
14.	Example of operator present function mode	47
15.	Application example for parallel automations	48

Key



This symbol indicates instructions or notes regarding safety, to which special attention must be paid.



This symbol indicates useful information for the correct functioning of the product.

1. General safety precautions



Failure to observe the information in this manual may result in minor personal injury or damage to equipment.
Save these instructions for future reference.



This installation manual is intended for qualified personnel only.

Installation, electrical connections and adjustments must be performed in accordance with Good Working Methods and in compliance with the present standards.

Read the instructions carefully before installing the product.

Bad installation could be dangerous.



The packaging materials (plastic, polystyrene, etc.) should not be discarded in the environment or left within reach of children, as these are a potential source of danger.

Before installing the product, make sure it is in perfect condition.

Do not install the product in explosive areas and atmospheres: the presence of inflammable gas or fumes represents a serious safety hazard.

The safety devices (photocells, safety edges, emergency stops, etc.) must be installed taking into account: applicable laws and directives, Good Working Methods, installation premises, system operating logic and the forces developed by the automation.



Before connecting the power supply, make sure the plate data correspond to that of the mains power supply.

An omnipolar disconnection switch with minimum contact gaps of 3 mm must be included in the mains supply.

Check that upstream of the electrical installation there is an adequate residual current circuit breaker and a suitable overcurrent cutout.

When requested, connect the automation to an effective earthing system that complies with current safety standards.

During installation, maintenance and repair operations, cut off the power supply before opening the cover to access the electrical parts.

The electronic parts must be handled using earthed antistatic conductive arms.



The manufacturer of the motorisation declines all responsibility in the event of component parts being fitted that are not compatible with the safe and correct operation.

Use original spare parts only for repairs or replacements of products.

1.1 Installation precautions

Fix the control panel permanently. Pass the cables along the lower side of the container.

If they are accessible, block the cables with cable glands (not supplied). Keep the line and motor conductors separated from the command conductors by at least 8mm in the terminal boards connection points (e.g. using straps).

Connect together the protection conductors (yellow/green) of the line and the motors, using the clamp supplied.

At the end of the installation, close the container.

2. EC Declaration of Conformity

The manufacturer Entrematic Group AB, with headquarters in Lodjursgatan 10, SE-261 44 Landskrona, Sweden, declares that the EL31R type control panel complies with the conditions of the following EC directives:

EMC Directive 2004/108/EC

Low Voltage Directive 2006/95/EC

R&TTE Directive 1999/5/EC

Landskrona, 29-01-2013

Marco Pietro Zini
(President & CEO)

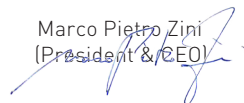

3. Technical specifications

	CROSS3E	ALTA5EH CROSS5EH CROSS5EH1	ALTA7EH CROSS7EH CROSS7EH1	QIK7EH QIK7YEH
Storage module	3M1CR3	3M1CR5 3M1CR5C5	3M1CR7 3M1CR7C5	3M1QK 3M1QKC7
Power supply	230 V~ 50/60 Hz	230 V~ 50/60 Hz	230 V~ 50/60 Hz	230 V~ 50/60 Hz
F1 fuse	F1,6A	F1,6A	F2A	F1,6A
Motor output	24 V $\overline{\text{=}}$ 8 A	24 V $\overline{\text{=}}$ 9,5 A	24 V $\overline{\text{=}}$ 14 A	24 V $\overline{\text{=}}$ 7 A
Accessories power supply	24 V $\overline{\text{=}}$ 0,3 A	24 V $\overline{\text{=}}$ 0,3 A	24 V $\overline{\text{=}}$ 0,3 A	24 V $\overline{\text{=}}$ 0,3 A
Temperature	min -20° C max +55° C	min -20° C max +55° C	min -20° C max +55° C	min -20° C max +55° C
Degree of protection	IP24D	IP24D	IP24D	IP24D
Radio frequency	433,92 MHz	433,92 MHz	433,92 MHz	433,92 MHz
Storable transmitters	100 [200-BIXMR2]	100 [200-BIXMR2]	100 [200-BIXMR2]	100 [200-BIXMR2]



N.B.: The given operating and performance features can only be guaranteed with the use of DITEC Entrematic accessories and safety devices.

3.1 Applications

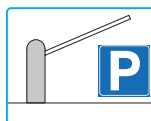
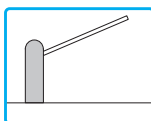
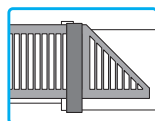
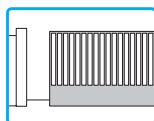











3M1CR5C5 ✓

3M1CR7C5 ✓



3M1QKC7 ✓

4. Commands

Command	Function	Description
1  5	N.O.	STEP-BY-STEP WITH AUTOMATIC CLOSING With DIP1A=OFF and TC<MAX, closing of the contact activates an opening or closing operation in the following sequence: opening-stop-closing-opening. N.B.: the stop is not permanent, but has the duration set with the TC trimmer.
		STEP-BY-STEP WITHOUT AUTOMATIC CLOSING With DIP1A=OFF and TC=MAX, closing of the contact activates an opening or closing operation in the following sequence: opening-stop-closing-opening.
		OPENING WITH AUTOMATIC CLOSING With DIP1A=ON and TC<MAX, closing of the contact activates an opening operation.
		OPENING WITHOUT AUTOMATIC CLOSING With DIP1A=ON and TC=MAX, closing of the contact activates an opening operation. N.B.: Once the automation stops, command 1-5 performs the opposite operation to the one performed before the stop.
1  6	N.O.	CLOSING With DIP2B=OFF, closing of the contact activates a closing operation.
1  6	N.C.	OPENING SAFETY CONTACT With DIP2B=ON, opening of the safety contact stops and prevents any movement.
1  8	N.C.	REVERSAL SAFETY CONTACT Opening the safety contact triggers a reversal of the movement (reopening) during the closing operation.
1  9	N.C.	STOP Opening the safety contact stops the current operation.
1  9	N.O.	OPERATOR PRESENT CONTROL Opening of contact 1-9 enables the operator present function. - opening with operator present 1-5 [with DIP1A=ON and TC=MAX]; - closing with operator present 1-6 [with DIP2B=OFF]. N.B.: any safety devices, automatic closing and plug-in cards in the AUX housing are disabled.
1  20	N.O.	PARTIAL OPENING With DIP3B=ON, closing of the contact activates a partial opening operation. Once the automation stops, the partial opening control performs the opposite operation to the one performed before the stop.
		AUTOMATIC CLOSING With DIP3B=OFF, permanent closing of the contact enables automatic closing.
1  20	N.O.	AUTOMATIC CLOSING Permanent closing of the contact enables automatic closing.
0  11	N.C.	CLOSING LIMIT SWITCH Opening of the contact stops the closing operation.
0  12	N.C.	OPENING LIMIT SWITCH Opening of the contact stops the opening operation.
41 		SAFETY TEST With DIP6A=ON, connecting terminal 41 enables a safety edge test cycle before every operation. If the test fails the SA LED flashes and the test is repeated.

CROSS



QIK

Command		Function	Description
	N.C.	SAFETY SWITCH	The SAFETY SWITCH contact is connected to the release system of the automation. Opening the release contact stops the operation.
	N.O.	TRANSMITTER STORAGE AND CANCELLATION	 WARNING: the storage module must be inserted. Transmitter storage: <ul style="list-style-type: none"> - press the PRG key (the SIG LED turns on), - proceed with transmission from the transmitter to be stored (the SIG LED flashes), - wait 10 s for storage to be completed (the SIG LED turns off). Transmitter cancellation: <ul style="list-style-type: none"> - press the PRG key for 3 s (the SIG LED flashes), - press the PRG key again for 3 s (the SIG LED flashes faster).







WARNING: make a jumper for all N.C. contacts if not in use. The terminals with the same number are equal.

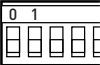

4.1 SOFA1-SOFA2 or GOPAVRS self-controlled safety edge

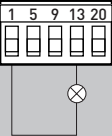
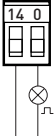
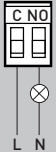
Command		Function	Description
		SAFETY TEST	Place the SOFA1-SOFA2 or GOPAVRS device into the special housing for AUX plug-in cards. With DIP6A=ON, connecting terminal 41 enables a safety edge test cycle before every operation. If the test fails the SA LED flashes and the test is repeated.
1  6	N.C.	SAFETY STOP	Connect the output contact of the device to terminals 1-6 on the control panel (in series with the photocell output contact, if installed). WARNING: if not used, make a jumper for terminals 41-6.
1  8	N.C.	REVERSE SAFETY CONTACT	Connect the output contact of the device to terminals 1-8 on the control panel (in series with the photocell output contact, if installed). WARNING: if not used, make a jumper for terminals 41-8.

5. Sliding gates outputs and accessories

Output	Value - Accessories	Description
	24 V $\overline{\text{=}}$ 0.3 A	Accessories power supply. Power supply output for external accessories, including automation status lamps.
AUX	SOFA1-SOFA2 GOPAV	The control panel is fitted with a housing for a plug-in card, such as radio receivers, magnetic loops, etc. Operating of the plug-in card is selected by DIP1A. WARNING: the plug-in cards must be inserted and removed with the power supply disconnected.
	STORAGE MODULE	The storage module allows remote controls to be stored and the type of control panel application to be defined (see TECHNICAL SPECIFICATIONS on page 4). If the control panel is replaced, the storage module being used can be inserted in the new control panel. WARNING: the storage module must be inserted and removed with the power supply disconnected.
	BATK3 2x12 V 2Ah	Barrier operation. The batteries are kept charged when the power supply is on. If the power supply is off, the panel is powered by the batteries until the power is re-establish or until the battery voltage drops below the safety threshold. The panel turns off in the last case. WARNING: the batteries must always be connected to the control panel for charging. Periodically check the efficiency of the batteries. N.B.: the operating temperature of the rechargeable batteries is approximately +5°C/+40°C.
	24 V $\overline{\text{=}}$ 3 W	Automation status light (proportional) The light goes off when the automation is closed. The light comes on when the automation is open. The light flashes with a variable frequency while the automation is operating.
	LAMPH 24 V $\overline{\text{=}}$ 25 W	Flashing light. The flashing light activates simultaneously with the opening and closing operation.
	LUXK3E LUXK7 230 V~ 60 W	Internal courtesy light. A courtesy light that turns on for 180 seconds with every opening (total or partial), step-by-step and closing command can be connected in series to the NO contact.  WARNING: use a double insulated cable
	230 V~ 400 W	External courtesy light. An external courtesy light that turns on for 180 seconds with every opening (total or partial), step-by-step and closing command can be connected.  WARNING: use a double insulated cable

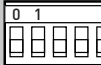
6. Barrier outputs and accessories

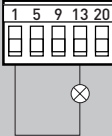
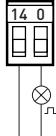
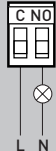
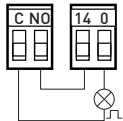
Output	Value - Accessories	Description
	24 V $\overline{\text{=}}$ 0,3 A	Accessories power supply. Power supply output for external accessories, including automation status lamps.
AUX	SOFA1-SOFA2 GOPAV	The control panel is fitted with a housing for a plug-in card, such as radio receivers, magnetic loops, etc. Operating of the plug-in card is selected by DIP1A. WARNING: the plug-in cards must be inserted and removed with the power supply disconnected.
COM 	STORAGE MODULE	The storage module allows remote controls to be stored and the type of control panel application to be defined (see TECHNICAL SPECIFICATIONS on page 4). If the control panel is replaced, the storage module being used can be inserted in the new control panel. WARNING: the storage module must be inserted and removed with the power supply disconnected.
	BATK3 2x12 V 2Ah	Barrier operation. The batteries are kept charged when the power supply is on. If the power supply is off, the panel is powered by the batteries until the power is re-establish or until the battery voltage drops below the safety threshold. The panel turns off in the last case. WARNING: the batteries must always be connected to the control panel for charging. Periodically check the efficiency of the batteries. N.B.: the operating temperature of the rechargeable batteries is approximately +5°C/+40°C.
	24 V $\overline{\text{=}}$ 3 W	Automation status lamp (proportional) The light goes off when the automation is closed. The light comes on when the automation is open. The light flashes with a variable frequency while the automation is operating.
	LAMPH 24 V $\overline{\text{=}}$ 25 W	Flashing light. WITH DIP5A=OFF it is activated during the opening and closing operations.
	230 V~ 400 W	External courtesy light. With DIP5A=OFF, a courtesy light can be connected in series to the NO contact, which activates for 180 s on each opening (total or partial), step-by-step and closing command.
	LAMPH 24 V $\overline{\text{=}}$ 25 W	Flashing light. WITH DIP5A=ON it is activated during the opening and closing operations.





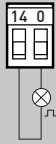
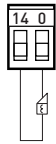

WARNING: use a double insulated cable

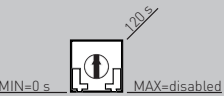

Output	Value - Accessories	Description
	QIKLUX 24 V $\overline{\text{~}}$ 300 mA max	Lighting kit. With DIP5A=ON, on with barrier closed, flashing with barrier operating and off with barrier open.
	QIKAFE 24 V $\overline{\text{~}}$ 300 mA max	Electric block. With DIP5A=ON it is activated with the barrier closed.



7. Settings

7.1 Trimmers



Trimmer	Description
VA - VC 	VA - Opening speed adjustment. Adjusts the opening speed. VC - Closing speed adjustment. Adjusts the closing speed.
TC 	Setting automatic closing time. From 0 to 120 s. With DIP3A=OFF, once a safety switch has been activated, the counter starts as soon as the safety switch is released (for example, after passing through the photocells), and lasts for a period of time set with TC (50%). WARNING: with QIK automations, automatic closing is immediate. With DIP3A=ON, the counter starts when automation is opened and lasts for the entire duration set with TC (100%). N.B.: after the activation of the stop command, once contact 1-9 has closed again, automatic closing is only enabled after a total, partial or step-by-step opening command.
TC 	With DIP3B=OFF, permanent closing of contact 1-20 enables automatic closing.
CROSS R1 	Power setting. The control panel is equipped with a safety device that stops motion if an obstacle is encountered during the opening operation and reverses motion during the closing operation.
QIK R1 	Adjustment of power and stop distance. It adjusts the power of the automation. With DIP7B=OFF, it adjusts the closing bar stop distance.



7.2 Sliding gates dip-switches

DIP A	Description	OFF 	ON 
DIP1A	Command functions 1-5. N.B.: it also sets operating on the AUX plug-in card.	Step-by-step	Opening.
DIP2A	Selecting opening direction. The opening direction is intended by viewing the automation from the side being examined.	Opening to the right.	Opening to the left.
DIP3A	Automatic closing time restore	50%	100%
DIP4A	Automation status at power on. Indicates how the control panel considers automation when powered up.	Open. N.B.: with limit switches installed, we recommend setting DIP4A=OFF.	Closed. N.B.: if the automatic closing function is not used, we recommend setting DIP4=ON.
DIP5A	Preflashing for 3 seconds.	Disabled during opening. Enabled only with automatic closing with TC >3 s.	Enabled for both opening and closing.
DIP6A	Safety test terminal 41.	Disabled.	Enabled.



DIP B	Description	OFF 	ON 
DIP1B	Reversal safety contact operation.	With automation stopped and contact 1-8 open, opening operations are permitted.	With automation stopped and 1-8 open, all operations are disabled.
DIP2B	Command functions 1-6.	Closing.	Stop.
DIP3B	Command functions 1-20.	Automatic closing on.	Partial opening command.
DIP4B	Selection of maximum working forces limit and adjustment of stop distance.	Normal closing force and reduced stop distance that changes according to speed.	Reduced closing force and longer stop distance irrespective of speed.
DIP5B	Encoder selection.	Automation without encoder. N.B.: stop limit switches must be installed.	Automation with encoder.
DIP6B	Current profile. (Automations with encoder only).	Disabled.	Enabled.
DIP7B	Approach speed adjustment.	Normal.	Reduced.
DIP8B	Electronic antifreeze system. Maintains motor efficiency even at low ambient temperatures.	Enabled.	Disabled.

7.3 Barrier dip-switches













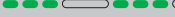



DIP A	Description	OFF 	ON 
DIP1A	Command functions 1-5. N.B.: it also sets operating on the AUX plug-in card.	Step-by-step	Opening.
DIP2A	Selecting opening direction. The opening direction is intended by viewing the automation from the side being examined.	Opening to the right.	Opening to the left.
DIP3A	Automatic closing time restore	0%	100%
DIP4A	Automation status at power on. Indicates how the control panel considers automation when powered up.	Open. N.B.: with limit switches installed, we recommend setting DIP4A=OFF.	Closed. N.B.: if the automatic closing function is not used, we recommend setting DIP4=ON.
DIP5A	Operating of output 0-14 and C-NO contact.	Flashing light and courtesy light.	Flashing light, lighting kit and electric block.
	Preflashing for 3 seconds.	Enabled only with automatic closing with TC >3 s.	
DIP6A	Safety test terminal 41.	Disabled.	Enabled.

DIP B	Description	OFF 	ON 
DIP1B	Reversal safety contact operation.	With automation stopped and contact 1-8 open, opening operations are permitted.	With automation stopped and 1-8 open, all operations are disabled.
DIP2B	Command functions 1-6.	Closing.	Stop.
DIP3B	Preflashing for 3 seconds before closing, after intervention of safety switch 1-8.	Disabled	Enabled
DIP4B	Selection of maximum working forces limit and adjustment of stop distance.	Normal closing force and reduced stop distance that changes according to speed.	Reduced closing force and longer stop distance irrespective of speed.
DIP5B	Stopping type selection.	Immediate.	Normal.
DIP7B	Stop distance adjustment during closing.	It allows the adjustment of the stop distance by means of trimmer R1.	Stopping fixed at 30°.
DIP8B	Electronic antifreeze system. Maintains motor efficiency even at low ambient temperatures.	Enabled.	Disabled.

7.4 Jumper

Jumper	Description	OFF 	ON 
JR1	Built-in radio receiver	Disabled	Enabled

7.5 Signals

LED	On	Flashing
POWER ALARM 	Power supply on.	<p> Encoder not working or DIP5B selection is not consistent with the encoder actually being or not being there.</p> <p> Current overload on flashing light output.</p> <p> Shortcircuiting of flashing light driver.</p>
IN 	Command received or change in status of a dip-switch.	/
SA 	At least one of the safety contacts is open. 1-9 contact is open. DIP6A selection is not consistent with the connection of terminals 6-8.	<p> Safety test failure (terminal 41).</p> <p>Operations count performed (only when control panel is switched on):  = 1000 operations  = 10000 operations</p>
11 	0-11 limit switch contact is open.	/
12 	0-12 limit switch contact is open.	/
SIG 	Transmitter enabling/storage phase.	<p> Radio transmission of a stored remote control received.</p> <p> Radio transmission of an unstored remote control received.</p> <p> Transmitter being cancelled.</p> <p> Damaged storage.</p>

8. Radio

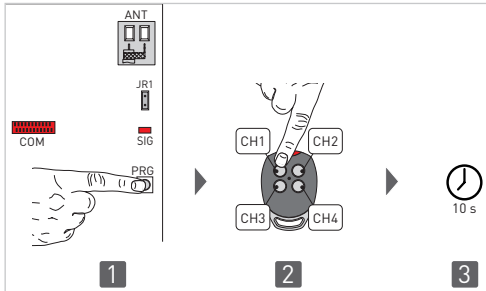

The control panel is equipped with a radio receiver with a frequency of 433.92 MHz.

The antenna consists of a rigid wire, 173 mm long, connected to the ANT clamp.

It is possible to increase the range of the radio by connecting the antenna of the flashing lights, or by installing the tuned BIXAL antenna.

N.B.: To connect the external antenna to the control panel, use a coaxial cable, type RG58 (max. 10 m).

Check that the storage module is inserted in the COM connector.

Up to 100 remote controls can be stored in the storage module.

WARNING: if the radio receiver on the control panel is not used, set JR1=OFF and remove the storage module.

Transmitter storage:

- Press the PRG key on the radio receiver or on the control panel; the SIG indicator LED lights up;
- Proceed with transmission by pressing the CH keys on the remote control that you want to store (within the range of the radio receiver). The remote control is now stored. During this phase, the SIG indicator LED flashes. When the SIG LED comes on again, you can validate another remote control. Validate all the new remote controls by making a transmission as indicated;
- You automatically exit the procedure 10 seconds after the last transmission, or you can press the PRG key again (the SIG LED goes off).

Up to four CH keys of a single remote control can be stored.

- If only one (any) CH key of the remote control is stored, command 1-5 (step-by-step/opening) is carried out;
- If 2-4 CH keys of a single remote control are stored, the functions matched with the CH keys are as follows:
 - CH1 = command 1-5 step-by-step/opening;
 - CH2 = partial opening command, it causes the automation to open for about 1 m;
 - CH3 = command to switch on/off the courtesy light;
 - CH4 = stop command, equivalent to impulsive command 1-9.

Transmitter cancellation:

- Hold down the PRG key for 3 s; the SIG LED starts to flash;
- To cancel all the remote controls from the memory, press the PRG key again, keeping it pressed for 3 s;
- To cancel a single remote control, press any one of the previously memorised CH keys of the remote control to be cancelled;
- The cancellation is confirmed by the quick flashing of the SIG LED.

For further information see the user manual for GOL series remote controls.

If the control panel is replaced, the storage module being used can be inserted in the new control panel.



WARNING: the storage module must be inserted and removed with the power supply disconnected.



For further information see the user manual for GOL series remote controls.

9. Working modes for sliding gates

The control panel can work in the following 3 modes:

- automations with encoder (DIP5B=ON) and without stop limit switches, the automation stops on the mechanical stops;
- automations with encoder (DIP5B=ON) and with stop limit switches, the automation stops after the stop limit switches have tripped;
- automations without encoder (DIP5B=OFF) and with stop limit switches, the automation stops after the stop limit switches have tripped.

In the automations with encoder (DIP5B=ON), by selecting DIP6B=ON, the control panel activates an innovative automatic detection system for the current necessary to move the automation at any point of the opening and closing operation.

The current stored profile shows the forces necessary for correct movement, taking the frictions into consideration.

The current profile is automatically updated every time an operation is completed (opening-closing) and it gradually adapts to the frictions resulting from progressive and natural ageing of the gate frame, reducing the need to service.

N.B.: The current profile is kept stored even in the event of a power failure.

10. Start-up

10.1 Starting the sliding gates

WARNING



The operations related to point 6 are performed without safeties. The trimmer can only be adjusted with the automation idle. The automation automatically slows when approaching the end stops or stop limit switches. After start-up the control panel receives a RESET and the first operation is performed at reduced speed (automation position acquisition).

- 1- Make a jumper for NC safety contacts.
- 2- Check that the storage module corresponding to the type of application selected is correctly plugged in.
- 3- Adjust the opening and closing stop limit switches, if any.
N.B.: limit switches must be kept pressed until the operation has been completed.
- 4- Set TC=MAX and R1=50%.
Select the desired opening direction with DIP2A.
Set DIP4B=OFF and DIP6B=OFF.
- 5- Manually move the sliding gate and make sure the entire stroke slides evenly and without friction.
- 6- Switch on and check the automation is operating correctly with the subsequent opening and closing commands.
Check that the limit switches are activated if used.
- 7- Connect the safety devices (removing the relative jumpers) and check they function correctly.
- 8- If desired, adjust the automatic closing time with the TC trimmer.
WARNING: the automatic closing time after a safety device has triggered depends on the DIP3A setting.
- 9- Set the desired opening and closing speed with the VA and VC trimmers.
- 10- Connect any other accessories and check they are functioning.
- 11- Set the obstacle thrust with the R1 trimmer.
To enable the current profile (see chapter 9) proceed as indicated:
 - set DIP6B=ON (any previously stored current profile is reset);
 - perform 2 complete operations (opening-closing).
- 12- For correct operating of the sliding gate with the correct operating forces, we recommend using the following settings:
 - gate without rubber edges: DIP4B=ON and DIP7B=ON;
 - gate with rubber edges: DIP4B=ON and DIP7B=OFF;
 - gate with self-controlled safety edges: DIP4B=OFF and DIP7B=OFF.WARNING: After adjusting, check that the working forces exerted by the door wings comply with standards EN12453-EN12445.



N.B.: in the event of servicing or if the control panel is to be replaced, repeat the start-up procedure.

10.2 Starting the barriers



WARNING

The operations related to point 6 are performed without safeties.

The trimmer can only be adjusted with the automation idle.

The automation automatically slows when approaching the end stops or stop limit switches. After start-up the control panel receives a RESET and the first operation is performed at reduced speed (automation position acquisition).

- 1- Make a jumper for NC safety contacts.
- 2- Check that the storage module corresponding to the type of application selected is correctly plugged in.
- 3- Adjust the opening and closing stop limit switches, if any.
N.B.: limit switches must be kept pressed until the operation has been completed.
- 4- Set TC=MAX and R1=50%.
Select the desired opening direction with DIP2A.
Set DIP4B=OFF and DIP6B=OFF.
- 5- Manually move the barrier bar and make sure it is correctly balanced.
- 6- Switch on and check the automation is operating correctly with the subsequent opening and closing commands.
Check that the limit switches are activated if used.
- 7- Connect the safety devices (removing the relative jumpers) and check they function correctly.
- 8- If desired, adjust the automatic closing time with the TC trimmer.
WARNING: the automatic closing time after a safety device has triggered depends on the DIP3A setting.
- 9- Set the desired opening and closing speed with the VA and VC trimmers.
WARNING: with QIK automations, for correct operation with a bar longer than 4.5 m, adjust the VA and VC trimmers to no more than 50%.
- 10- Connect any other accessories and check they are functioning.



N.B.: in the event of servicing or if the control panel is to be replaced, repeat the start-up procedure.

11. Troubleshooting

Problem	Possible causes	Operation
The automation does not open or close.	No power. (POWER ALARM LED off).	Check that the control panel is powered correctly.
	Short circuited accessories. (POWER ALARM LED off).	Disconnect all accessories from terminals 0-1 (a voltage of 24V= must be present) and reconnect them one at a time.
	Blown line fuse. (POWER ALARM LED off).	Replace fuse F1.
	Safety contacts are open. (SA LED on).	Check that the safety contacts are closed correctly (NC). Check the DIP6A setting.
	Safety contacts not correctly connected or self-controlled safety edge not functioning correctly. (flashing SA LED).	Check connections to terminals 6-8 on control panel and connections to the self-controlled safety edge.
	SAFETY SWITCH release microswitch open. (LEDs 11 and 12 on).	Check that the hatch is closed correctly and the microswitch makes contact.
	No storage module or incorrect storage module. (SA and POWER ALARM LEDs flashing alternately).	Switch the automation off and plug in the correct storage module.
	The remote control does not work.	Check the correct memorisation of the transmitters on the built-in radio. If there is a fault with the radio receiver that is built into the control panel, the remote control codes can be read by removing the storage module.
	Photocells activated. (SA LED on).	Check that the photocells are clean and operating correctly.
	The automatic closing does not work.	Check that the TC trimmer is not set at the maximum or check the DIP3B=ON setting.
The external safety devices are not activated.	Incorrect connections between the photocells and the control panel.	Connect NC safety contacts together in series and remove any jumpers on the control panel terminal board.
The automation opens/closes briefly and then stops.	Encoder disconnected, false encoder contacts, encoder fault. (flashing POWER ALARM LED).	Check that the encoder is connected correctly, clean the contacts by connecting and disconnecting the encoder plug on the contacts, replace encoder. Check the DIP5B setting.
	Motor leads crossed. (flashing POWER ALARM LED).	Check the motor leads.
	There is a presence of friction.	Manually check that the automation moves freely and check the R1 adjustment.

The remote control has limited range and does not work with the automation moving.

The radio transmission is impeded by metal structures and reinforced concrete walls.

Install the antenna outside.

Substitute the transmitter batteries.

12. Application example for sliding gates

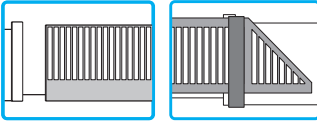

When using the control panel for sliding automation applications:

- Select the correct opening direction with DIP2A

(Example 1). When using the control panel for sliding gate applications:

- connect the opening and closing limit switch NC contacts to terminals 0-11-12 if required.

With this configuration, the wing stops when the limit switches are activated.

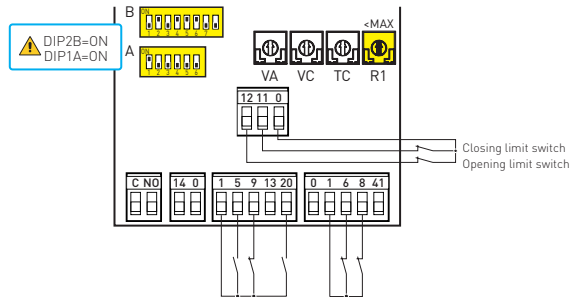

(Example 2). The remote control can be used with step-by-step functioning and, at the same time, terminal 5 with opening function by making the connections indicated and setting DIP1A=OFF.

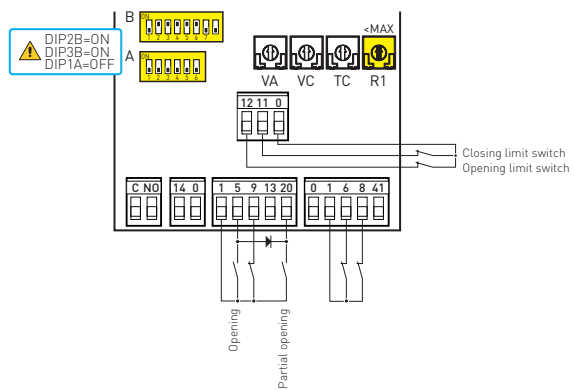

N.B.: if the self-controlled safety edge SOFA1-SOFA2 is used, make the connections indicated in paragraph 4.1.



WARNING: with CROSS5EH1 and CROSS7EH1 automations with a limit switch and without encoder, you must set DIP5B=OFF and DIP6B=OFF.

13. Application example for barriers

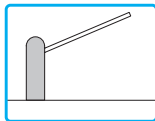

When using the control panel for barrier applications:

- Select the correct opening direction with DIP2A.

Connect the opening and closing limit switch NC contacts to terminals 0-11-12.

With this configuration, the barrier stops when the limit switches are activated.

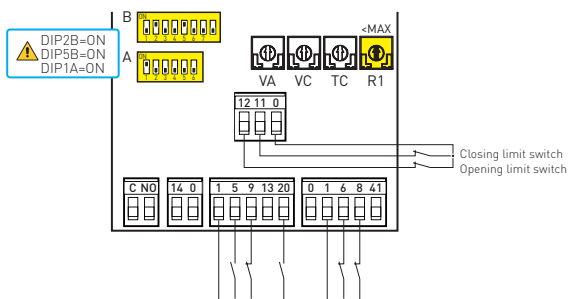

14. Operator present function modes

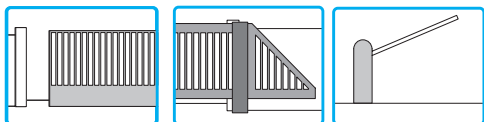

Quando il quadro elettronico viene usato in modalità "uomo presente":

- scollegare il morsetto 9;
- impostare il senso di marcia mediante DIP2A=OFF;

In questa condizione, i comandi di apertura (1-5) e di chiusura (1-6) funzionano solo se mantenuti premuti, al loro rilascio l'automazione si ferma.

La chiusura automatica e i comandi radio sono disabilitati.

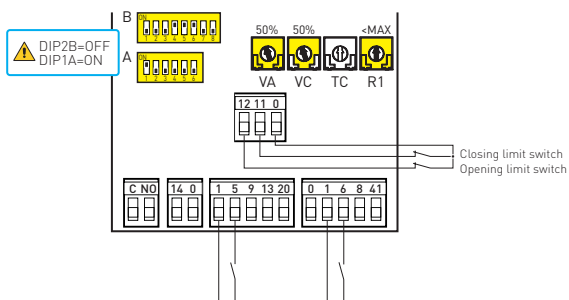

15. Example of parallel automations

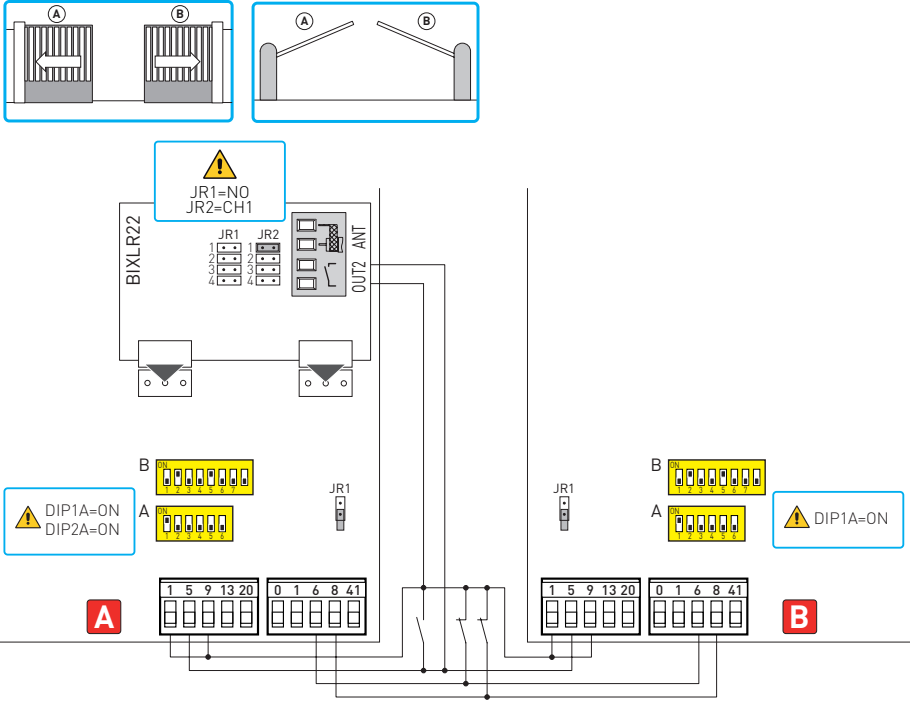

It is possible to command two automations [A] and [B] in parallel with the connections and settings indicated in the figure.

Step-by-step commands (1-5) and radio controls are like an opening command.

To manage both automations with a single remote control, do not use the radio receivers on the control panels (JR1=OFF), but insert a BIXLR22 radio receiver.

Adjust TC, VA and VC trimmers in the same position on both control panels.



N.B.: the opening and closing movements may not be synchronised.

All the rights concerning this material are the exclusive property of Entrematic Group AB. Although the contents of this publication have been drawn up with the greatest care, Entrematic Group AB cannot be held responsible in any way for any damage caused by mistakes or omissions in this publication. We reserve the right to make changes without prior notice. Copying, scanning and changing in any way are expressly forbidden unless authorised in writing by Entrematic Group AB.

ENTRE//MATIC



Entrematic Group AB
Lodjursgatan 10
SE-261 44, Landskrona
Sweden
www.ditecentrematic.com

